



[Home](#) > [Products](#) > [Programmable Logic Controllers - PLCs](#) > MicroSmart Pentra

MicroSmart Pentra

Overview

IDEC strives to give you the best product for your dollar, and our controllers are just that! Offering speed, power, performance and precision are just the tip of the iceberg. The true benefit to using an IDEC controller is that it will cut your development time in half. These reliable controllers are easy to use, easy to maintain and easy to repair. No boards to build and maintain. No approvals to get. No spare parts to worry about. Just a simple, ready-made solution that won't require time you don't have to give. Instead, count on saving time with faster response, better throughput, reduced waste and less downtime.



NEW 12VDC

Demand for 12VDC control voltage has grown as solar and vehicle applications gain popularity and require PLCs to match their power sources. With abundant features and unparalleled performance, the new 12VDC MicroSmart Pentra is the perfect choice for solar applications, including traffic signs, light controls, road sign controls, remote pumping and injections systems for oil & gas industries, remote water pumping stations and solar tracking systems. For vehicle applications, 12VDC MicroSmart Pentra can be utilized in utilities vehicle such as cement mixer, lift controls for handicap, lighting and designation signs for van and buses.

Key Features

- Fast processing speed
- Support 32-bit data and floating point math
- 16-bit analog resolution
- Built-in Modbus RTU, ASCII and TCP/IP
- Field Upgradeable Firmware
- Up to 512 I/Os
- Configure up to 56 Analog I/Os
- Max. of 7 Communication Ports
- Embedded 100kHz high speed I/O
- Online Edit and Simulation Mode

Highlights of MicroSmart Controllers

Global Standards

All MicroSmart controllers have regulatory agency certifications for the worldwide market including: cULus Listed for Class I Division 2 hazardous locations, CE compliant, and certified for marine use by Lloyd's Registry.

Compatibility

For added convenience, the same expansion I/O modules and accessories can be used on both the MicroSmart and MicroSmart Pentra controllers. In fact, both controllers also share the same architecture, instruction set and programming software. The use of a single platform for all IDEC

PLCs means you won't have to reprogram or learn a new system to alternate from one to another.

Simple Programming

Relax. Programming doesn't need to be hard or take a lot of your time. With IDEC WindLDR Software, you can configure, modify and monitor your MicroSmart programs with ease. This powerful and intuitive software makes it simple to get your system up and running. Now supporting Online Editing and Simulation mode.

Compact and Modular Design

Every CPU module comes equipped with embedded I/O points or you can conveniently add additional snap-on expansion modules for up to 512 I/Os based on your system requirements. All IDEC controllers are DIN-rail and panel mountable.

Customizable Structure

Feel the freedom. The ability to customize for the functions you need allows you to create the perfect system for your applications. Add an HMI module, a Real Time clock module or even an optional EEPROM module.

MicroSmart Pentra Series

FC5A-C24R2C

[MicroSmart Pentra the fastest MicroPLC in its class! Available in either Slim/Book Style and All-In-One type]





Product Specifications

PLC Product Category	CPU Unit
Operating Voltage	24V DC
Maximum PID Loops	32
High Speed Counter(s)	50kHz, 5kHz

High Speed Counter Input Type Sink, Source

RS485 Ports 1, Separate Module Required

On Board Communication Port 1 RS-232

Memory Card Slot Yes

On Board Input Type Transistor Sink, Transistor Source

On Board Output Type Relay

I/O Expandable Yes

Maximum I/O 88

On Board I/O 14/10

Real Time Clock Yes, Separate Module Required

Connector Type Screw Terminal

Notes MicroSmart All-in-One Brick Style PLC. Expandable I/O cards purchased separately. See catalog pages for further information.

I/O Range Requirement 24 or less, 25-88

Floating Point Math Yes

Data Processing 32 Bit

Max. Communication Ports 1, 2

Maximum Analog Points 8 Input / 4 Output

MicroSmart Pentra CPU Part Numbers

All-in-One

Appearance	Part Number	Power	I/O Points	Input	Output	Expandability	
	FC5A-C10R2C	24V DC	10 (6 in/4 out)			N/A	
	FC5A-C10R2	100-240V AC					
	FC5A-C16R2C	24V DC	16 (9 in/7 out)	24V DC (Sink/Source)	Relay		
	FC5A-C16R2	100-240V AC					
	FC5A-C24R2C	24V DC	24 (14 in/10 out)				88 Maximum I/O (up to 4 expansion modules)
	FC5A-C24R2	100-240V AC					

Slim

Appearance	Part Number	Power	I/O Points	Input	Output	Expandability
	FC5A-D16RK1	24V DC	16 (8 in/8 out)	24V DC (Sink/Source)	6 Relays, 2 Transistor Sink	496 Maximum I/O (up to 15 expansion modules)
	FC5A-D16RS1				6 Relays, 2 Transistor Source	
	FC5A-D32K3*		32 (16 in/16 out)		Transistor Sink	512 Maximum I/O (up to 15 expansion modules)
	FC5A-D32S3*				Transistor Source	



*See page 20 for MIL Connector Cables and Breakout Modules.

PLCs

Operator Interfaces

Automation Software

Power Supplies

Sensors

Communication & Networking

Specifications

All-in-One

Part Number	AC Power	FC5A-C10R2	FC5A-C16R2	FC5A-C24R2	FC4A-C10R2	FC4A-C16R2	FC4A-C24R2
	DC Power	FC5A-C10R2C	FC5A-C16R2C	FC5A-C24R2C	FC4A-C10R2C	FC4A-C16R2C	FC4A-C24R2C
Rated Voltage	AC power model: 100 to 240V AC, DC power model: 24V DC						
Allowable Voltage Range	AC power model: 85 to 264V AC, DC power model: 20.4 to 28.8V DC (including ripple)						
Rated Power Frequency	AC power model: 50/60 Hz (47 to 63 Hz)						
Maximum Input Current		250mA (85V AC) 160mA (24V DC)	300mA (85V AC) 190mA (24V DC)	450mA (85V AC) ¹ 360mA (24V DC) ²	250mA (85V AC) 160mA (24V DC)	300mA (85V AC) 190mA (24V DC)	450mA (85V AC) ² 360mA (24V DC) ³
Maximum Power Consumption	AC Power	FC5A-C10R2/FC4A-C10R2: 30VA (264V AC) / 20VA (100V AC) ³ FC5A-C16R2/FC4A-C16R2: 31VA (264V AC) / 22VA (100V AC) ³ FC5A-C24R2/FC4A-C24R2: 40VA (264V AC) / 33VA (100V AC) ¹					
	DC Power	FC5A-C10R2C/FC4A-C10R2C: 3.9W (24V DC) ⁴ FC5A-C16R2C/FC4A-C16R2C: 4.6W (24V DC) ⁴ FC5A-C24R2C/FC4A-C24R2C: 8.7W (24V DC) ²					
Allowable Momentary Power Interruption	10ms (rated power voltage)						
Dielectric Strength	Between power and ⊕ or ⊖ terminals: 1500V AC, 1 minute Between I/O and ⊕ or ⊖ terminals: 1500V AC, 1 minute						
Insulation Resistance	Between power and ⊕ or ⊖ terminals: 10 MΩ minimum (500V DC megger) Between I/O and ⊕ or ⊖ terminals: 10 MΩ minimum (500V DC megger)						
Noise Resistance	AC power terminals: 1.5 kV, 50 ns to 1μs DC power terminals: 1.0 kV, 50 ns to 1μs I/O terminals (coupling clamp): 1.5 kV, 50 ns to 1μs						
Inrush Current		35A		40A		35A	40A
Power Supply Wire	UL1015 AWG22, UL1007 AWG18						
Operating Temperature	0 to 55°C						
Storage Temperature	-25 to +70°C (no freezing)						
Relative Humidity	Level RH1 (IEC61131-2), 1 to 95% RH (no condensation)						
Altitude	Operation: 0 to 2,000m, Transport: 0 to 3,000m						
Pollution Degree	2 (IEC60664-1)						
Corrosion Immunity	Free from corrosive gases						
Degree of Protection	IP20 (IEC60529)						
Grounding Wire	UL1007, AWG16						
Vibration Resistance	When mounted on a DIN rail or panel surface: 5 to 9 Hz amplitude 3.5 mm, 9 to 150 Hz acceleration 9.8 m/s ² (1G), 2 hours per axis on each of three mutually perpendicular axes (IEC61131-2)						
Shock Resistance	147 m/s ² (15G), 11ms duration, 3 shocks per axis, on three mutually perpendicular axes (IEC61131)						
Weight		AC: 230g DC: 240g	AC: 250g DC: 260g	AC: 305g DC: 310g	AC: 230g DC: 240g	AC: 250g DC: 260g	AC: 305g DC: 310g

- 1. CPU module (including 250mA sensor power) + 4 I/O modules
- 2. CPU module + 4 I/O modules
- 3. CPU module (including 250mA sensor power)
- 4. CPU module (24V DC)

PLCs

Operator Interfaces

Automation Software

Power Supplies

Sensors

Communication & Networking

All-in-One

Part Number		FC5A-C10R2 FC5A-C10R2C	FC5A-C16R2 FC5A-C16R2C	FC5A-C24R2 FC5A-C24R2C	FC4A-C10R2 FC4A-C10R2C	FC4A-C16R2 FC4A-C16R2C	FC4A-C24R2 FC4A-C24R2C
Control System		Stored program system					
Instruction Words		35 basic					
Program Capacity ¹		13.8 KB (2,300 steps)	27 KB (4,500 steps)	54 KB (9,000 steps)	4.8 KB (800 steps)	15 KB (2,500 steps)	27 KB (4,500 steps)
User Program Storage		EEPROM (10,000 times rewritable)					
Processing Time	Basic Instruction	1.16ms (1,000 steps)			1.65ms (1,000 steps)		
	END Processing ²	0.64ms			0.64ms		
Expandable I/O Module		—		4 modules		—	
I/O Points	Input	6	9	14	Expansion: 64	6	9
	Output	4	7	10		4	7
Internal Relay		2,048 points		256 points		1,024 points	
Shift Register		128 points		64 points		128 points	
Data Register		2,000 points		400 points		1,300 points	
Extra Data Register		—		—		—	
Counter		256 points		32 points		100 points	
Timer (1-sec, 100-ms, 10-ms, 1-ms)		256 points		32 points		100 points	
RAM Backup	Backup Data	Internal relay, shift register, counter, data register					
	Backup Duration	Approx. 30 days (typical) at 25°C after backup battery fully charged					
	Battery	Lithium secondary battery					
	Charging Time	Approx. 15 hours for charging from 0% to 90% of full charge					
	Battery Life	5 years					
	Replaceability	N/A					
Self-diagnostic Function		Power failure, watchdog timer, data link connection, user program EEPROM sum check, timer/counter preset value sum check, user program RAM sum check, keep data, user program syntax, user program writing, CPU module, clock IC, I/O bus initialize, user program execution					
Input Filter		Without filter or 3 to 15ms filter (selectable in increments of 1ms)					
Catch Input/Interrupt Input		Four inputs (I2 through I5) Minimum turn on pulse width: 40µs minimum Minimum turn off pulse width: 150µs minimum					
High-speed Counter	Maximum Counting Frequency and High-speed Counter Points	Total 4 points Single/two-phase selectable: 50KHz (1 point) Single-phase: 5KHz (3 points)			Total 4 points Single/two-phase selectable: 20KHz (1 point) Single-phase: 5KHz (3 points)		
	Counting Range	0 to 65535 (16 bits)					
	Operation Mode	Rotary encoder mode and adding counter mode					
Analog Potentiometer	Number	1 point		2 points		1 point	
	Data Range	0 to 255					
Analog Voltage Input	Number	—					
	Input Voltage Range	—					
	Input Impedance	—					
Pulse Output	Data Range	—					
	Number	—					
Sensor Power Supply (AC Power Only)	Max. Frequency	—					
	Output Voltage Current	24V DC (+10% to -15%), 250mA					
	Overload Detection	N/A					
Isolation		Isolated from the internal circuit					
Port 1		RS232C (maintenance communication, user communication)					
Port 2 Communication Adapter (option) ³		Possible	Possible	Possible	—	Possible	Possible
Clock Cartridge (option)		Possible	Possible	Possible	Possible	Possible	Possible
Memory Cartridge (option)		Possible	Possible	Possible	Possible	Possible	Possible
HMI Module (option)		Possible	Possible	Possible	Possible	Possible	Possible



1. 1 step equals 6 bytes.
 2. Not including expansion I/O service time, clock function processing time, data link processing time, and interrupt processing time.
 3. Maintenance communication, user communication, Modem communication, datalink, Modbus master/slave communication (FC5A only).
- Note: The maximum number of relay outputs that can be turned on simultaneously is 33 including those on the CPU module.

PLCs

Operator Interfaces

Automation Software

Power Supplies

Sensors

Communication & Networking

Communication Port (RS232C Port 1)

Model	Slim CPU	All-in-One CPU
Standards	EIA RS232C	
Maximum Baud Rate	FC5A: 57,600 bps (maintenance communication) FC4A: 19,200 bps (maintenance communication)	
Maintenance Communication	Possible	
User Communication	Possible	
Modem Communication	N/A	
Data Link	N/A	
Cable	Special cable (FC2A-KC4C, FC2A-KP1C, FC4A-KC1C, FC4A-KC2C)	
Isolation between Internal Circuit and Communication Port	Not isolated	

Input Specifications

Part Number	—	FC5A-D16RK1 FC5A-D16RS1	—	FC5A-D32K3 FC5A-D32S3	—	FC5A-C10R2 FC5A-C10R2C	FC5A-C16R2 FC5A-C16R2C	FC5A-C24R2 FC5A-C24R2C
	FC4A-D20K3 FC4A-D20S3	—	FC4A-D20RK1 FC4A-D20RS1	—	FC4A-D40K3 FC4A-D40S3	FC4A-C10R2 FC4A-C10R2C	FC4A-C16R2 FC4A-C16R2C	FC4A-C24R2 FC4A-C24R2C
Input Points	12 (12/1 common)	8 (8/1 common)	12 (12/1 common)	16 (8/1 common)	24 (12/1 common)	6 (6/1 common)	9 (9/1 common)	14 (14/1 common)
Input Voltage	24V DC sink/source input signal							
Input Voltage Range	20.4 to 26.4V DC					20.4 to 28.8V DC		
Input Current	FC5A I0, I1, I3, I4, I6, I7: 4.5mA/point (24V DC) I2, I5, I10 to I17: 7mA/point (24V DC) FC4A I0, I1, I6, I7: 5mA/point (24V DC) I2 to I5, I10 to I27: 7mA/point (24V DC)					FC5A I0 and I1: 6.4mA/point I2 to I7, I10 to I15: 7mA/point (24V DC) FC4A I0 and I1: 11mA I2 to I7, I10 to I15: 7mA/point (24V DC)		
Input Impedance	FC5A I0, I1, I3, I4, I6, I7: 4.9kΩ I2 to I5, I10 to I17: 3.4kΩ FC4A I0, I1, I6, I7: 5.7kΩ I2 to I5, I10 to I17: 3.4kΩ					FC5A I0 and I1: 3.7kΩ I2 to I7, I10 to I15: 3.4kΩ FC4A I0 and I1: 2.1kΩ I2 to I7, I10 to I15: 3.4kΩ		
Turn ON Time	FC5A I0, I1, I3, I4, I6, I7: 5μs + filter value I2 and I5: 35μs + filter value I10 to I17: 40μs + filter value FC4A I0, I1, I6, I7: 35μs + filter value I2 to I5: 35μs + filter value I10 to I27: 40μs + filter value					FC5A I0 and I1: 2μs + filter value I2 to I7: 35μs + filter value I6, I7, I10 to I15: 40μs + filter value FC4A I0 and I1: 35μs + filter value I2 to I5: 35μs + filter value I6, I7, I10 to I15: 40μs + filter value		
Turn OFF Time	FC5A I0, I1, I3, I4, I6, I7: 5μs + filter value I2 and I5: 150μs + filter value I10 to I17: 150μs + filter value FC4A I0, I1, I6, I7: 45μs + filter value I2 to I5: 150μs + filter value I10 to I27: 150μs + filter value					FC5A I0 and I1: 16μs + filter value I2 to I7: 150μs + filter value I6, I7, I10 to I15: 150μs + filter value FC4A I0 and I1: 45μs + filter value I2 to I5: 150μs + filter value I6, I7, I10 to I15: 150μs + filter value		
Connector	On Mother Board	FL26A2MA (Oki Electric Cable)	MC1.5/18-G-3.81BK (Phoenix Contact)	FL26A2MA (Oki Electric Cable)	—			
	Insertion Durability	100 times minimum					—	
Isolation	Between input terminals: Photocoupler isolated Internal circuit: Not isolated							
Input	Type 1 (IEC61131-2)							
External Load for I/O Interconnection	Not needed							
Single Determination Method	Static							
Effect of Improper Input Connection	Both sinking and sourcing input signals can be connected. If any input exceeding the rated value is applied, permanent damage may be caused.							
Cable Length	3 m in compliance with electromagnetic immunity							

PLCs
Operator Interfaces
Automation Software
Power Supplies
Sensors
Communication & Networking
Transistor Sink and Source Output

Part Number	—	FC5A-D16RK1 FC5A-D16RS1	FC5A-D32K3 FC5A-D32S3
	FC4A-D20RK1 FC4A-D20RS1	—	FC4A-D40K3 FC4A-D40S3
Output Points	2 (2/1 common)	2 (2/1 common)	16 (8/1 common)
Output	Transistor Sink	FC5A-D16K1/D32K3 FC4A-D20K3/D20RK1/D40K3	
	Transistor Source	FC5A-D16RS1/D32S3 FC4A-D20S3/D20RS1/D40S3	
Load Voltage	24V DC		
Operating Load Voltage Range	20.4 to 28.8V DC		
Load Current	0.3A per output point		
Maximum Load Current	1A per common		
Voltage Drop (ON Voltage)	1V maximum (voltage between COM and output terminals when output is on)		
Inrush Current	1A		
Leakage Current	0.1mA maximum		
Clamping Voltage	39V±1V		
Maximum Lamp Load	8W		
Inductive Load	L/R = 10ms (28.8V DC, 1 Hz)		
External Current Draw	Sink output: 100mA maximum, 24V DC (power voltage at the +V terminal) Source output: 100mA maximum, 24V DC (power voltage at the -V terminal)		
Isolation	Between output terminal and internal circuit: Photocoupler isolated Between output terminals: Not isolated		
Connector on Mother Board	FL26A2MA (Oki Electric Cable)	MC1.5/16-G-3.81BK (Phoenix Contact)	FL26A2MA (Oki Electric Cable)
Connector Insertion/Removal Durability	100 times minimum		
Output Delay	Turn ON Time	FC5A Q0 to Q2: 5µs max. Q3 to Q7, Q10 to Q17: 300µs max. FC4A Q0, Q1: 5µs max. Q2 to Q7, Q10 to Q17: 300µs max.	
	Turn OFF Time	FC5A Q0 to Q2: 5µs max. Q3 to Q7, Q10 to Q17: 300µs max. FC4A Q0, Q1: 5µs max. Q2 to Q7, Q10 to Q17: 300µs max.	

Relay Output

Part Number	FC5A-C10R2 FC5A-C10R2C	FC5A-C16R2 FC5A-C16R2C	FC5A-C24R2 FC5A-C24R2C	FC5A-D16RK1 FC5A-D16RS1	
	FC4A-C10R2 FC4A-C10R2C	FC4A-C16R2 FC4A-C16R2C	FC4A-C24R2 FC4A-C24R2C	FC4A-D20RK1 FC4A-D20RS1	
No. of Outputs	4	7	10	8	
Output Points per Common Line	COM0	3	4	4	2 (Transistor output)
	COM1	1	2	4	3
	COM2	—	1	1	2
	COM3	—	—	1	1
Output	1 NO form A				
Maximum Load Current	2A per point 8A per common line				
Minimum Switching Load	0.1mA/0.1V DC (reference value)				
Initial Contact Resistance	30 mΩ maximum				
Electrical Life	100,000 operations minimum (rated load 1,800 operations/hour)				
Mechanical Life	20,000,000 operations minimum (no load 18,000 operations/hour)				
Rated Load	240V AC/2A (resistive load, inductive load cos φ = 0.4) 30V DC/2A (resistive load, inductive load L/R = 7ms)				
Dielectric Strength	Between output and terminals: 1,500V AC, 1 minute Between output terminal and internal circuit: 1,500V AC, 1 minute Between output terminals (COMs): 1,500V AC, 1 minute				
Connector on Mother Board	—			*	
Connector Insertion/Removal Durability	—			100 times minimum	



*MC1.5/16-G-3.81BK (Phoenix Contact)

PLCs

Operator Interfaces

Automation Software

Power Supplies

Sensors

Communication & Networking

Dimensions (mm)

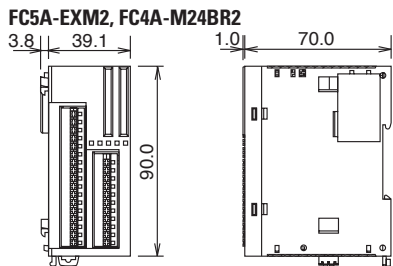
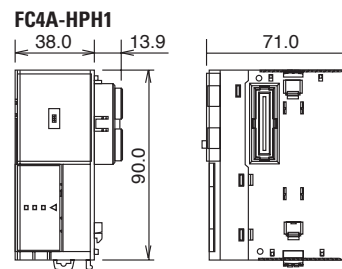
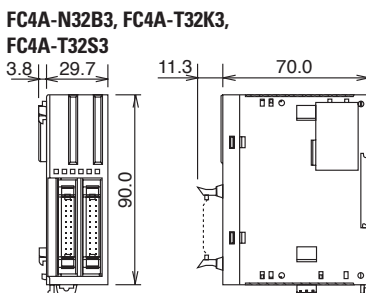
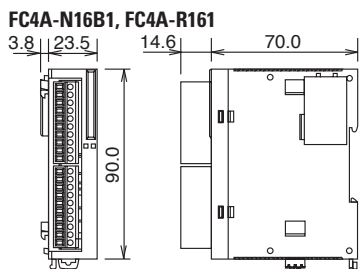
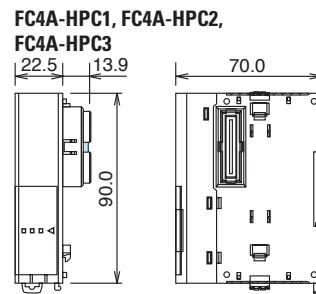
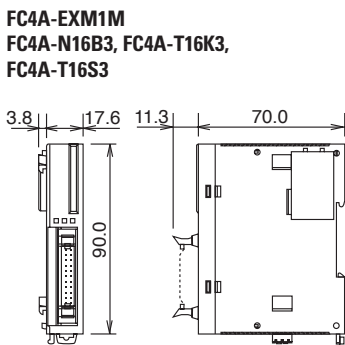
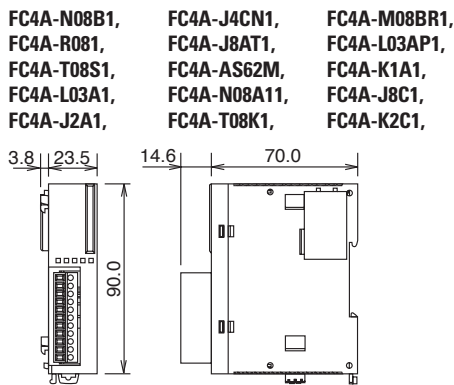
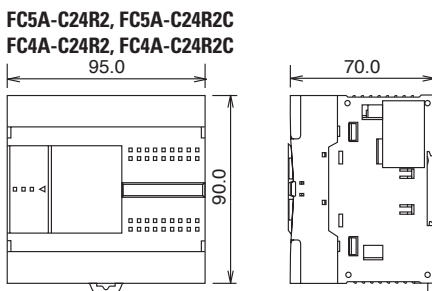
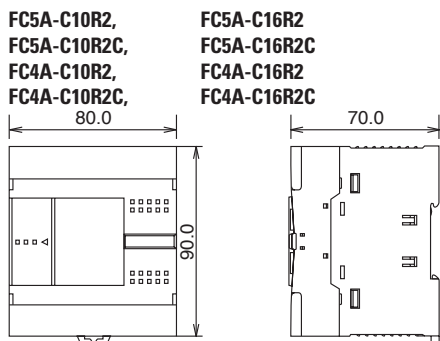
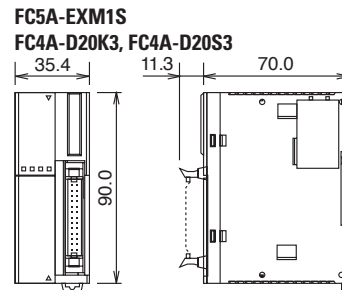
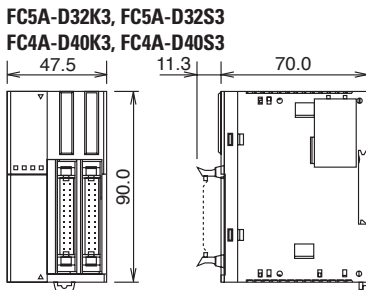
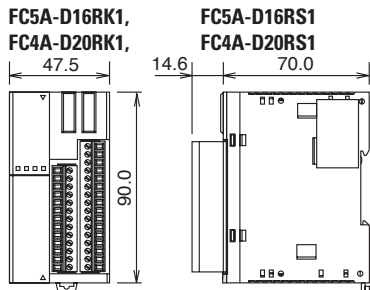

Example

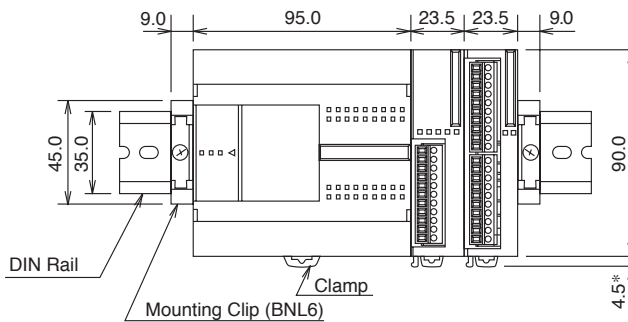

The figure illustrates a system setup consisting of the all-in-one 24-I/O CPU module, an 8-point relay output module, and a 16-point DC input module mounted on a 35-mm-wide-DIN rail using BNL6 mounting clips.

Mounting Hole Layout (mm)

FC5A-C10R2, FC5A-C16R2
 FC5A-C10R2C, FC5A-C16R2C
 FC4A-C10R2, FC4A-C16R2
 FC4A-C10R2C, FC4A-C16R2C

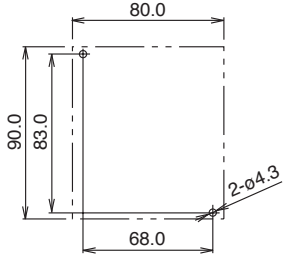

FC4A-N08A11, FC4A-R081
 FC4A-R161, FC4A-T08K1
 FC4A-T08S1, FC4A-M08BR1
 FC4A-L03A1, FC4A-L03AP1
 FC4A-J2A1, FC4A-K1A1
 FC4A-J4CN1, FC4A-T8C1
 FC4A-J8AT1, FC4A-K2C1

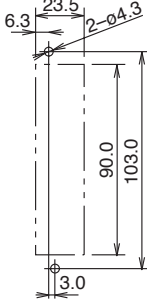

FC5A-EXM2
 FC4A-M24BR2

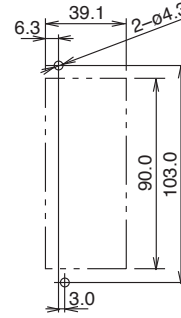

FC5A-EXM1S, FC4A-D20K3
 FC4A-D20S3

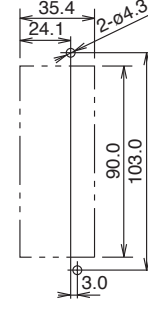

FC5A-C24R2, FC4A-C24R2C
 FC4A-C24R2, FC4A-C24R2C

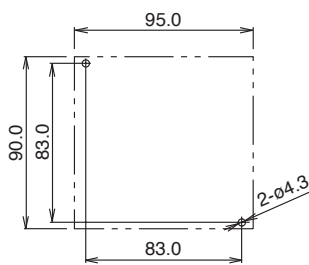

FC5A-EXM1M
 FC4A-N16B3, FC4A-T16K3,
 FC4A-T16S3

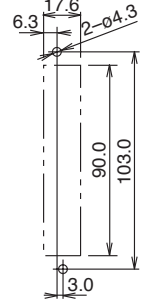

FC4A-HPC1 FC4A-HPC2
 FC4A-HPC3

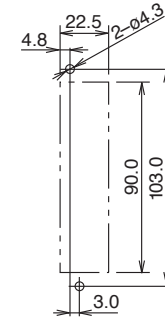

FC4A-N32B3, FC4A-T32K3,
 FC4A-T32S3

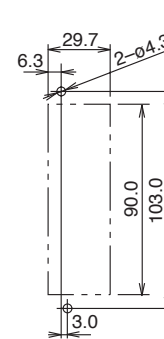

FC5A-D16RK1
 FC5A-D16RS1
 FC5A-D32K3
 FC5A-D32S3
 FC4A-D20RK1
 FC4A-D20RS1
 FC4A-D40K3
 FC4A-D40S3

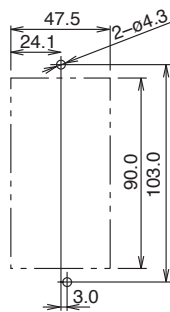

FC4A-HPH1

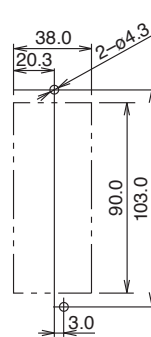

FC4A-HPH1

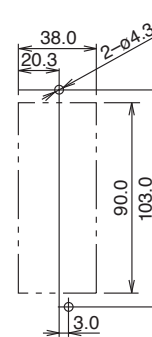

Examples

Mounting hole layout for FC5A-C24R2 or FC4A-C24R2 and four 23.5mm-wide I/O modules

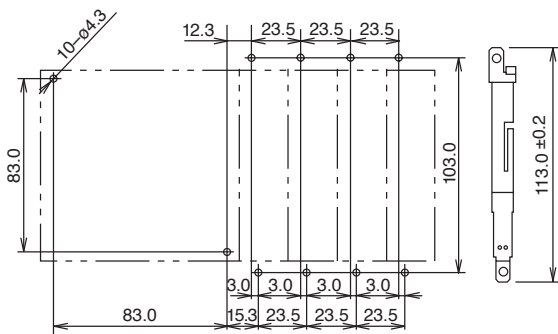

Mounting hole layout from left, FC4A-HPH1, FC4A-D20K3, FC4A-N16B3, FC4A-N32B3, and FC4A-M24BR2 modules

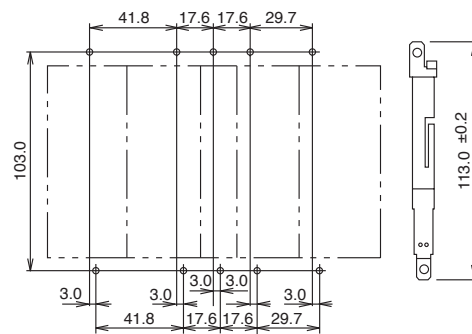

Web Server

General Specifications

Rated Power Voltage	24V DC
Allowable Voltage Range	20.4 to 26.4V DC
Current Draw	70 mA
Allowable Momentary Power Interruption	10 ms maximum
Dielectric Strength	500V AC, 1 minute
Insulation Resistance	10 MΩ minimum (500V DC megger)
Noise Resistance	DC power terminal: 1.0 kV, 50 ns to 1 μs Ethernet cable: 0.5 kV, 50 ns to 1 μs (coupling clamp)
Inrush Current	4A maximum
Operating Temperature	0 to 55°C
Storage Temperature	-40 to +70°C (no freezing)
Relative Humidity	10 to 95% (no condensation)
Pollution Degree	2 (IEC 60664-1)
Corrosion Immunity	Free from corrosive gases
Degree of Protection	IP20 (IEC60529)
Vibration Resistance	When mounted on a DIN rail: 5 to 9 Hz amplitude 3.5 mm 9 to 150 Hz acceleration 9.8 m/s ² (1G) 2 hours in each of 3 axes
Shock Resistance	147 m/s ² (15G), 11 ms duration 3 shocks each in 3 axes
Weight (approx.)	150g

Interface Specifications

Communication	RS232C <=> Ethernet conversion function
Ethernet Specifications	Electrical characteristics: Complies with IEEE802.3 Transmission speed: 10BASE-T/100BASE-TX (Not CE compliant) Communication protocol: IP/ICMP/ARP Ethernet protocol: TCP/SMTP/HTTP/Telnet No. of TCP connections: 1
Serial Interface Specifications	Electrical characteristics: EIA RS232C Transmission speed: 9600 to 115200 bps Synchronization: Asynchronous Communication protocol: Full duplex Transmission control: RTS/CTS, XON/OFF, None
Connection Method	Ethernet interface: RJ45 Serial interface: Mini DIN 8-pin connector Cable Part No.: FC4A-KC3C
Major Functions	Remote maintenance: Uploading, downloading and monitoring using WindLDR via Ethernet Web server: Configure the web server unit using Internet Explorer etc. Reading and writing PLC operands using Java applet. Web file area: 512 KB Compliant browser: Internet Explorer 6.0 or higher, Netscape Navigator 7.2 Ethernet user communication: User communication using Ethernet Message transmission: Registered outgoing message 32 message types, 63 characters maximum per message, 2 email addresses, 64 address characters maximum
Optional	Utility CD: Configuration file, PLC operand monitor sample programs, sample program configuration instructions, instruction manual (English/German/Spanish/Japanese/Chinese)

Connectable Devices

Programmable Controllers

IDEC FC5A MicroSmart
IDEC FC4A MicroSmart
IDEC FC3A OpenNet Controller

Operator Interface

(RS232C communication with PLC through Ethernet)
IDEC HG2F

Dimensions

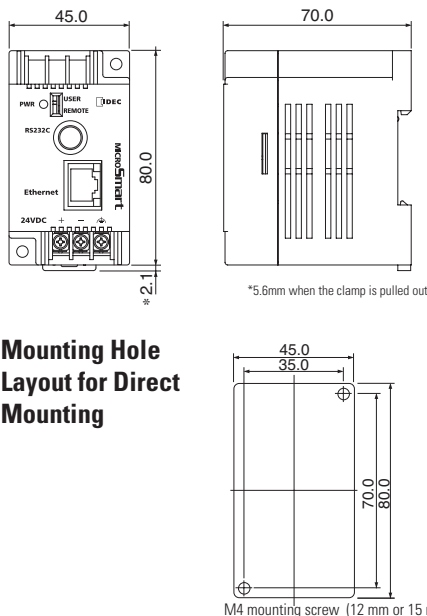

Web Server Cable (FC4A-KC3C, Cable Length: 100 mm)

Cable Dimensions



Connector Pinout

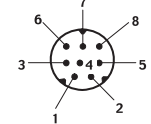

Cable Connection Diagram

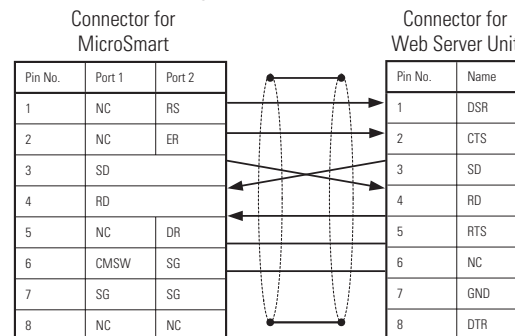

Ethernet is a registered trademark of Xerox Corporation.